

VERSION	AMENDMENT	AUTHORISED BY	DATE

HELD BY LANDGATE IN DIGITAL FORMAT ONLY
FOR INTERESTS AND NOTIFICATIONS
SEE SHEET 3

TYPE	FREEHOLD	S.S.A.	YES
PURPOSE	SUBDIVISION		
PLAN OF	LOTS 1100-1105, 1114-1134, 9006, ROADS, EASEMENTS AND RESTRICTIVE COVENANT		
FORMER TENURE	SEE FORMER TENURE TABLE		
LOCAL AUTHORITY	CITY OF ARMADALE		
LOCALITY	HAYNES		
D.O.L. FILE			
FIELD RECORD	122296		

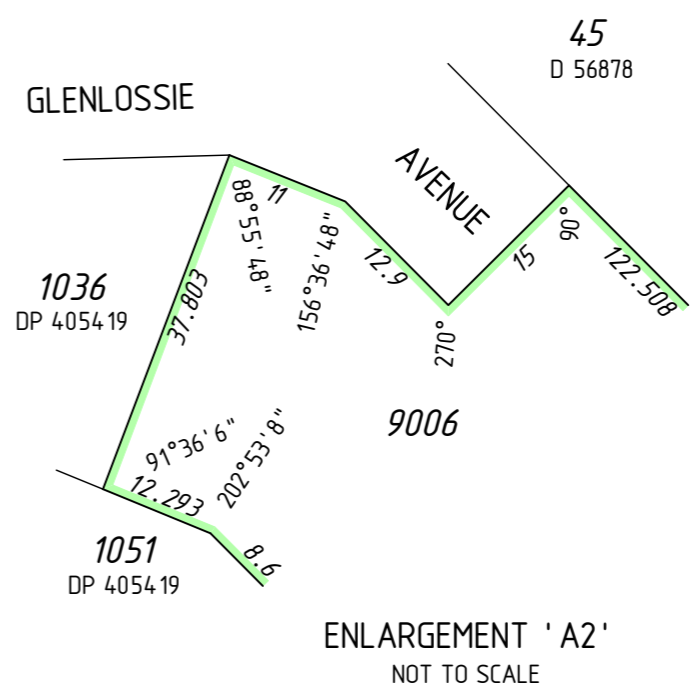
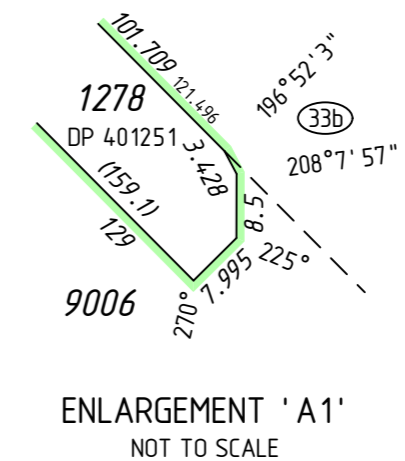
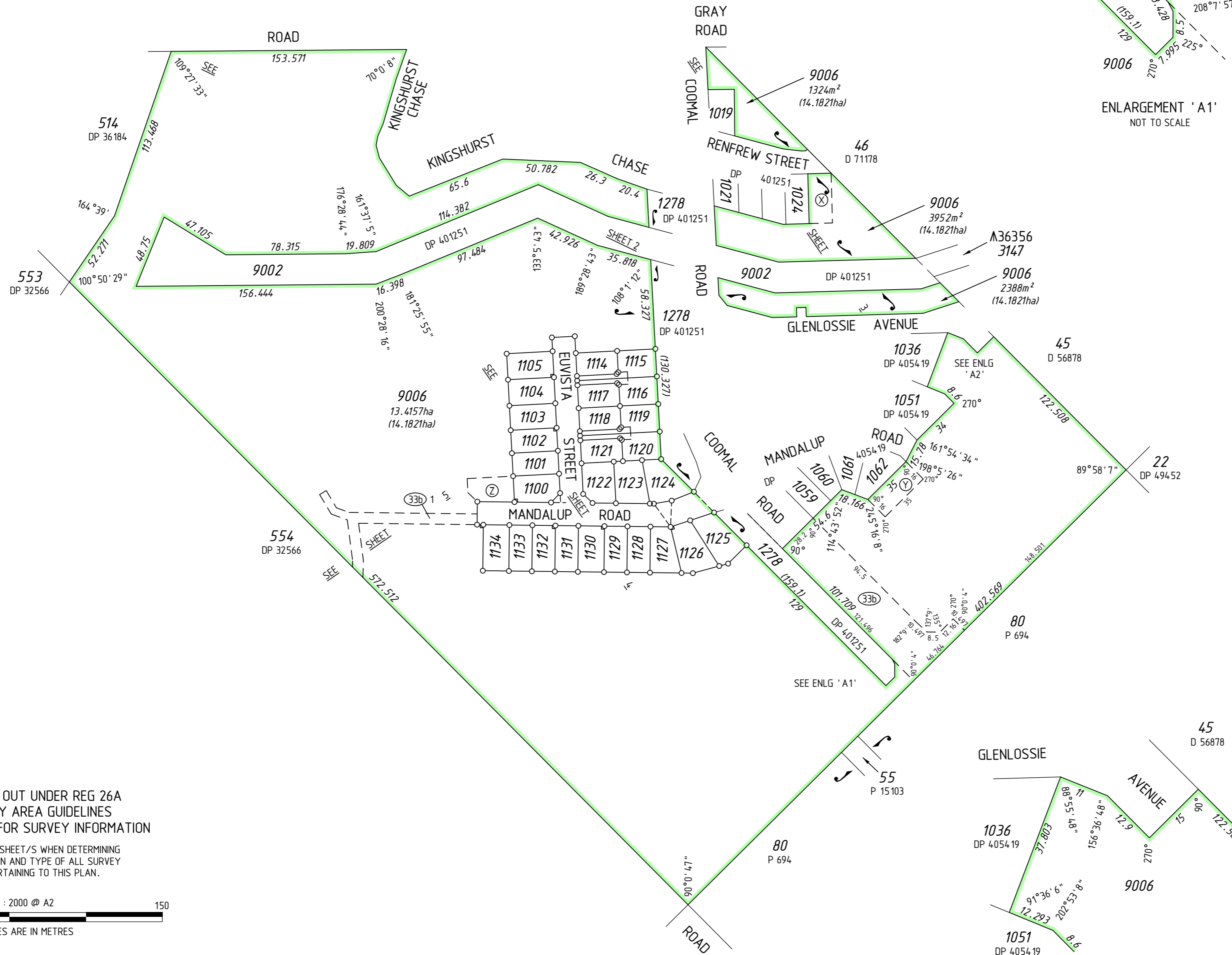

SURVEY CARRIED OUT UNDER REG 26A
SPECIAL SURVEY AREA GUIDELINES
SEE SURVEY SHEETS FOR SURVEY INFORMATION

USE ONLY THE SURVEY SHEET/S WHEN DETERMINING
THE TRUE FINAL POSITION AND TYPE OF ALL SURVEY
MARKS PLACED PERTAINING TO THIS PLAN.

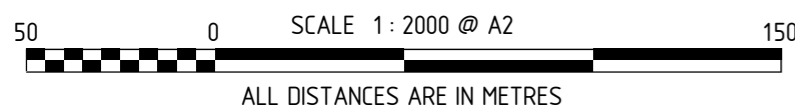

FORMER TENURE TABLE

LOT	FORMER TENURE	ON PLAN / DIAGRAM	TITLE
1100, 1105, 1114-1120, 1124, 1125, 1130-1134	PT LOT 9005	DP 4054.19	C/T 2890-885
1101-1104, 1121-1123, 1126-1129, 9006	PT LOT 9004 PT LOT 9005	DP 401251 DP 4054.19	C/T 2785-76 C/T 2890-885

SURVEYOR'S CERTIFICATE - REG 54
I, Charles A. YOUNGE
hereby certify that this plan is accurate and is a correct
representation of the -
(a) *survey, and/or
(b) *calculations from measurements recorded in the field records,
[* delete if inapplicable]
undertaken for the purposes of this plan and that it
complies with the relevant written law(s) in relation to
which it is lodged.

FINAL
LICENSED SURVEYOR DATE
LOGGED
DATE FEE PAID ASSESS No.

I.S.C.
EXAMINED
DATE

WESTERN AUSTRALIAN PLANNING COMMISSION
FILE 147233
Delegated under S. 16 P&D Act 2005 DATE

IN ORDER FOR DEALINGS
FOR INSPECTOR OF PLANS AND SURVEYS DATE

APPROVED REG26A (4)
INSPECTOR OF PLANS AND SURVEYS DATE
(S. 18 Licensed Surveyors Act 1909)



DEPOSITED PLAN

406530

SHEET 01 OF 05 SHEETS
(PLUS SURVEY SHEET(S))
VERSION 1

MC MULLEN NOLAN GROUP
PO Box 3526, Success W.A. 6964
Tel: (08) 6436 1599
Fax: (08) 6436 1500
Email: info@mngsurvey.com.au
MNG Ref : 97602dp-051f - Stage 2B - DP406530.CSD

FOR HEADING SEE SHEET 1

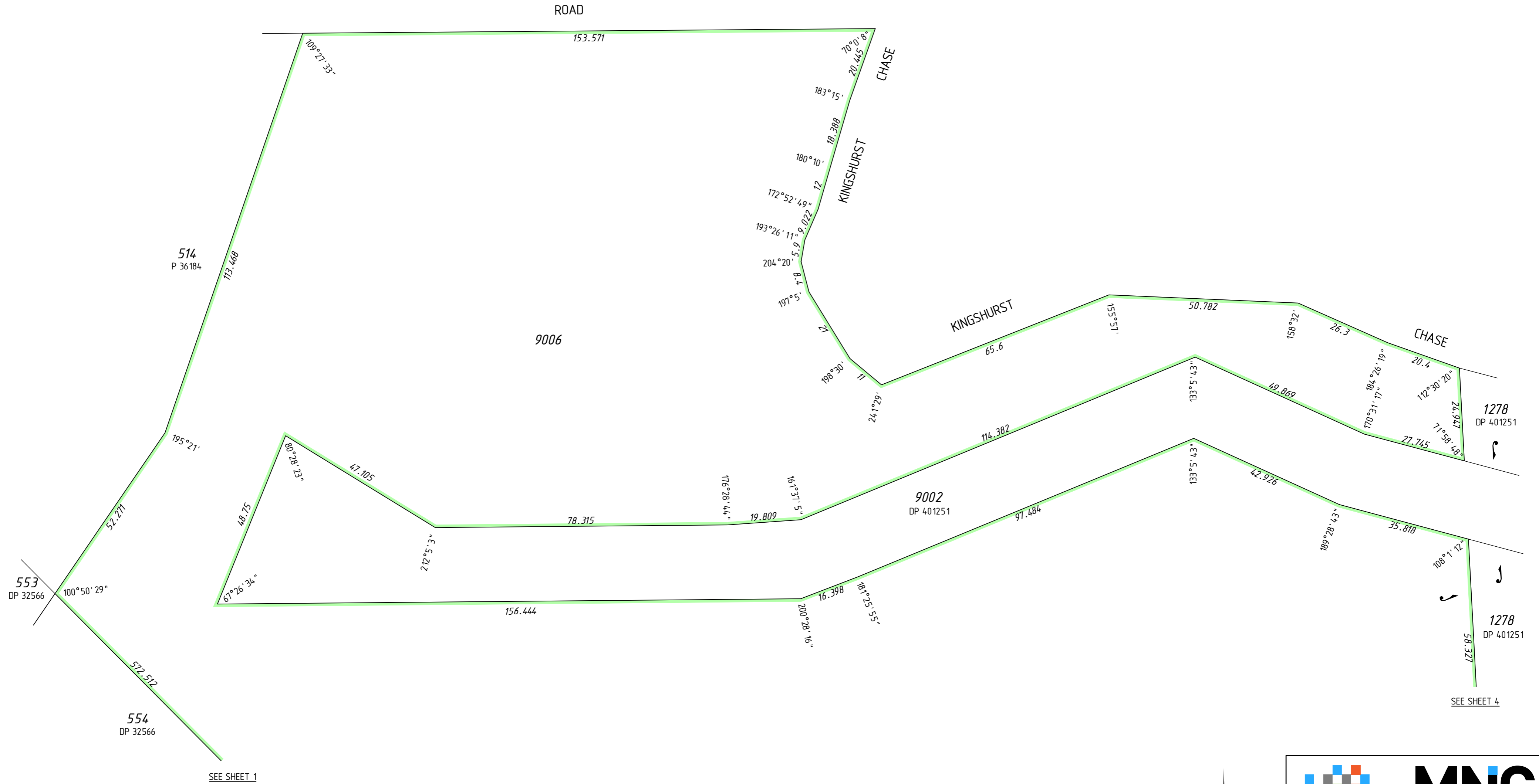

FOR INTERESTS AND NOTIFICATIONS
SEE SHEET 3

SURVEY CARRIED OUT UNDER REG 26A
SPECIAL SURVEY AREA GUIDELINES

USE ONLY THE SURVEY SHEET/S WHEN DETERMINING
THE TRUE FINAL POSITION AND TYPE OF ALL SURVEY
MARKS PLACED PERTAINING TO THIS PLAN.

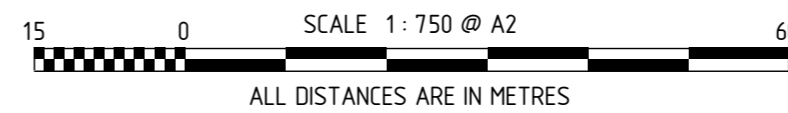

MNG Ref : 97602dp-051f - Stage 2B - DP406530.CSD

FINAL	DATE
LICENSED SURVEYOR	



DEPOSITED PLAN
406530
SHEET 02 OF 05 SHEETS
VERSION 1

INTERESTS AND NOTIFICATIONS

SUBJECT	PURPOSE	STATUTORY REFERENCE	ORIGIN	LAND BURDENED	BENEFIT TO	COMMENTS
33b 1	EASEMENT (Sewerage)	SEC 167 OF THE P. & D. ACT REG 33 (b)	DP 401251	LOT 9006	WATER CORPORATION	
	EASEMENT (Drainage)	SEC 136C OF THE T.L.A.	DP 401251	LOT 1024 ON DP 401251	LOT 9006 ⊗	
	EASEMENT (Drainage)	SEC 136C OF THE T.L.A.	DP 405419	LOT 1062 ON DP 405419	LOT 9006 ⊙	
33b	EASEMENT (Water Supply)	SEC 167 OF THE P. & D. ACT REG 33 (b)	THIS PLAN	LOT 9006	WATER CORPORATION	
A	EASEMENT (DRAINAGE)	SEC 136C OF THE T.L.A.	THIS PLAN	LOT 1115	LOTS 1114, 1116 & 1117	
B	EASEMENT (DRAINAGE)	SEC 136C OF THE T.L.A.	THIS PLAN	LOT 1116	LOTS 1114, 1115 & 1117	
C	EASEMENT (DRAINAGE)	SEC 136C OF THE T.L.A.	THIS PLAN	LOT 1119	LOTS 1118, 1120 & 1121	
D	EASEMENT (DRAINAGE)	SEC 136C OF THE T.L.A.	THIS PLAN	LOT 1120	LOTS 1118, 1119 & 1121	
R1100	EASEMENT (DRAINAGE)	SEC 136C OF THE T.L.A.	THIS PLAN	LOT 1100	LOT 9006 ⊙	
R1102	EASEMENT (DRAINAGE)	SEC 136C OF THE T.L.A.	THIS PLAN	LOT 1102	LOT 1103	
R1105	EASEMENT (DRAINAGE)	SEC 136C OF THE T.L.A.	THIS PLAN	LOT 1105	LOT 1104	
R1126	EASEMENT (DRAINAGE)	SEC 136C OF THE T.L.A.	THIS PLAN	LOT 1126	LOT 1127	
R1130	EASEMENT (DRAINAGE)	SEC 136C OF THE T.L.A.	THIS PLAN	LOT 1130	LOT 1129	
R1132	EASEMENT (DRAINAGE)	SEC 136C OF THE T.L.A.	THIS PLAN	LOT 1132	LOT 1131	
R1135	EASEMENT (DRAINAGE)	SEC 136C OF THE T.L.A.	THIS PLAN	LOT 9006	LOT 1134	
R1115	RIGHT OF CARRIAGEWAY	SEC 136C OF THE T.L.A.	THIS PLAN	LOT 1115	LOT 1116	
R1116	RIGHT OF CARRIAGEWAY	SEC 136C OF THE T.L.A.	THIS PLAN	LOT 1116	LOT 1115	
R1119	RIGHT OF CARRIAGEWAY	SEC 136C OF THE T.L.A.	THIS PLAN	LOT 1119	LOT 1120	
R1120	RIGHT OF CARRIAGEWAY	SEC 136C OF THE T.L.A.	THIS PLAN	LOT 1120	LOT 1119	
	RESTRICTIVE COVENANT	SEC 136D OF THE T.L.A.	THIS PLAN & DOC	LOTS 1100-1105 & 1114-1134	LOTS 1100-1105 & 1114-1134	
	NOTIFICATION	SEC 70A OF THE T.L.A.	DOC	LOTS 1100-1105 & 1114-1134		WATER SENSITIVE URBAN DESIGN REQUIREMENTS
	NOTIFICATION	SEC 165 OF THE P & D ACT	DOC	LOTS 1100-1105 & 1114-1134		MOSQUITOS

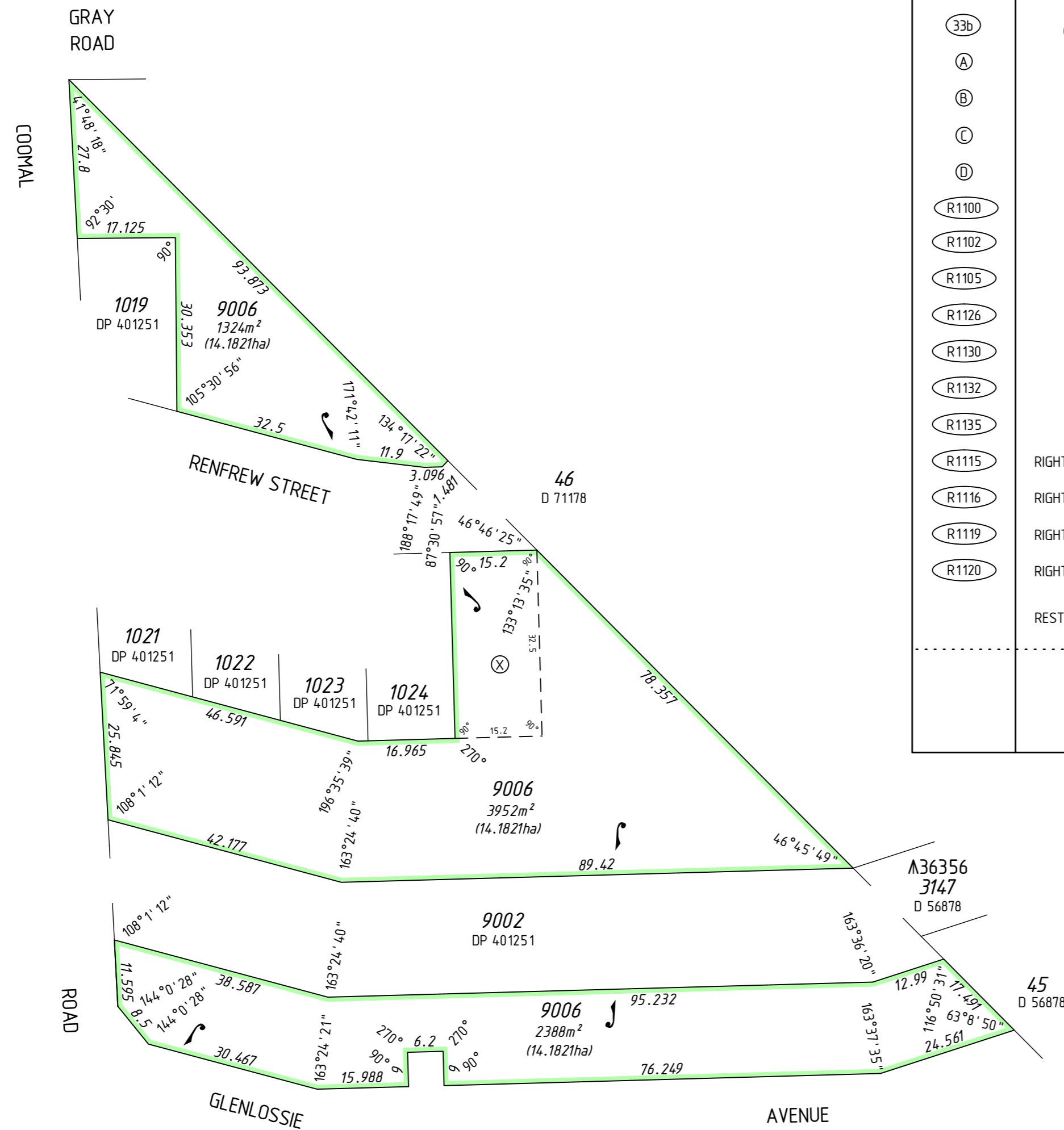

SURVEY CARRIED OUT UNDER REG 26A
SPECIAL SURVEY AREA GUIDELINES
USE ONLY THE SURVEY SHEET/S WHEN DETERMINING
THE TRUE FINAL POSITION AND TYPE OF ALL SURVEY
MARKS PLACED PERTAINING TO THIS PLAN.

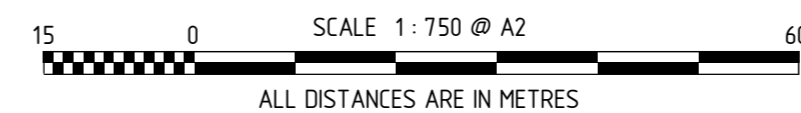

MNG Ref : 97602dp-051f - Stage 2B - DP406530.CSD

FINAL
LICENSED SURVEYOR DATE



DEPOSITED PLAN
406530
SHEET 03 OF 05 SHEETS
VERSION 1

FOR HEADING SEE SHEET 1

FOR INTERESTS AND NOTIFICATIONS
SEE SHEET 3

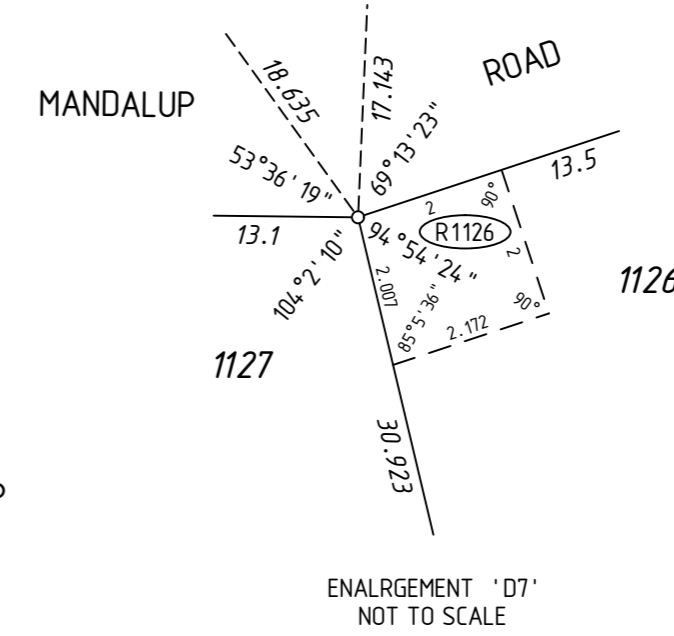
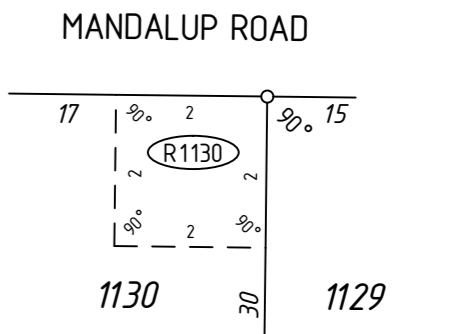
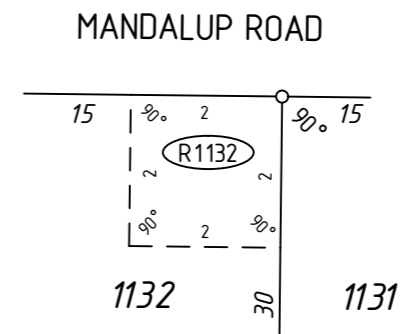
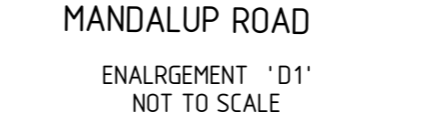
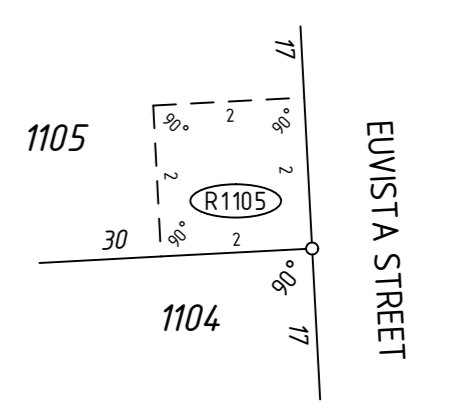
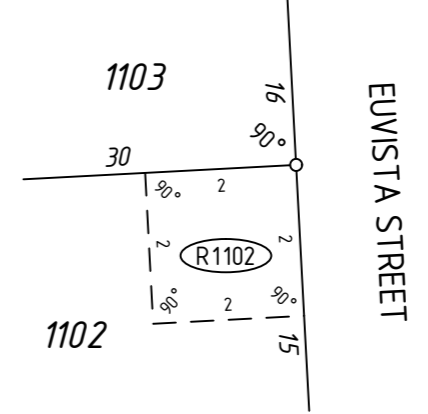
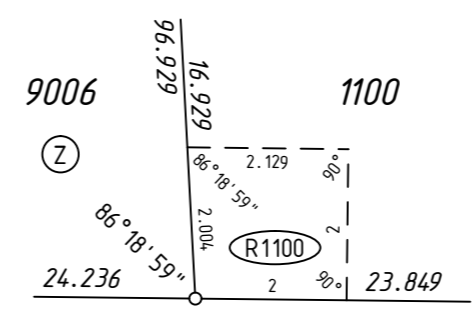
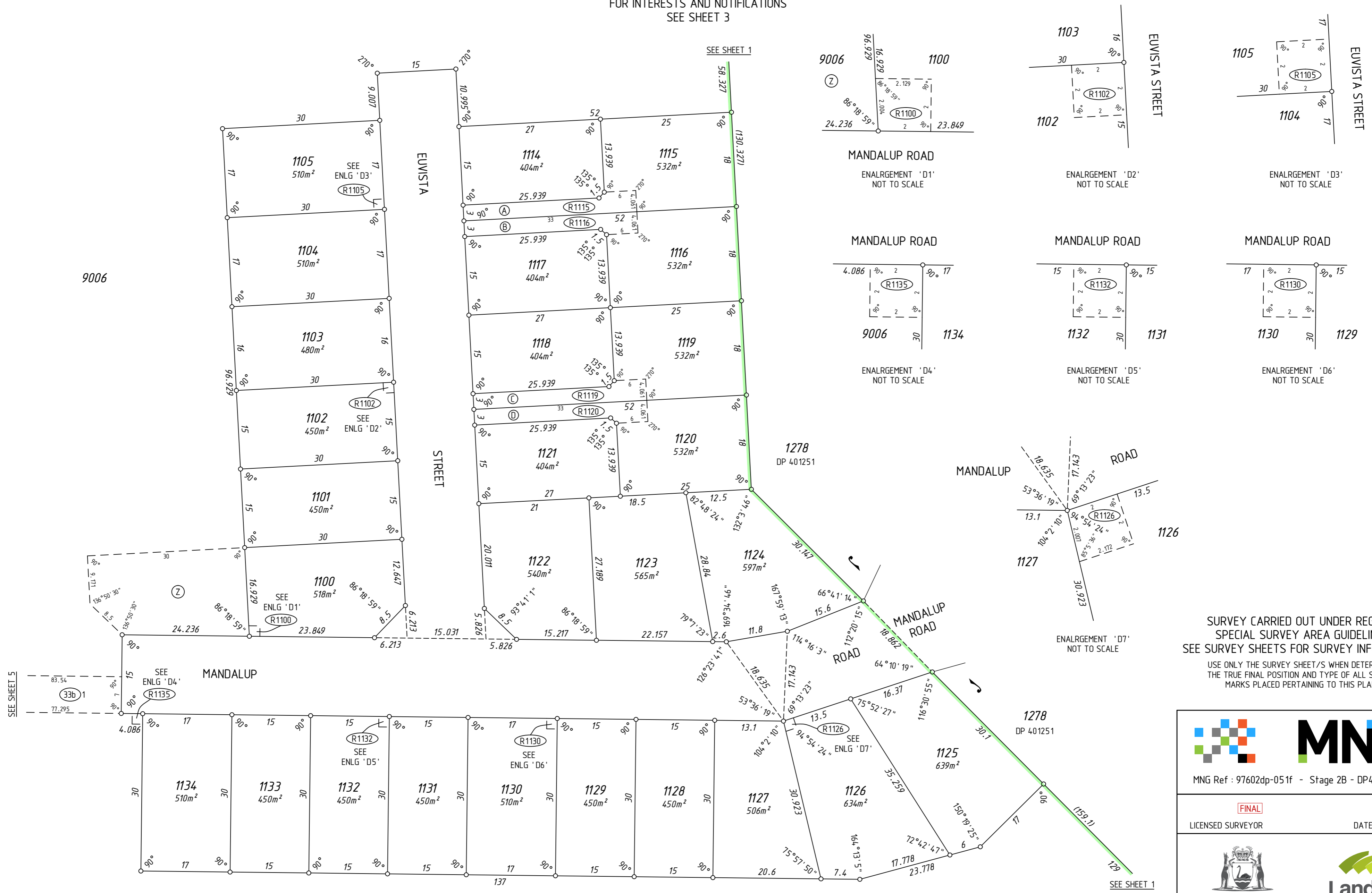

SURVEY CARRIED OUT UNDER REG 26A
SPECIAL SURVEY AREA GUIDELINES
SEE SURVEY SHEETS FOR SURVEY INFORMATION

USE ONLY THE SURVEY SHEET/S WHEN DETERMINING
THE TRUE FINAL POSITION AND TYPE OF ALL SURVEY
MARKS PLACED PERTAINING TO THIS PLAN.



MNG Ref : 97602dp-051f - Stage 2B - DP406530.CSD

FINAL
LICENSED SURVEYOR DATE



DEPOSITED PLAN
406530
SHEET 04 OF 05 SHEETS
VERSION 1

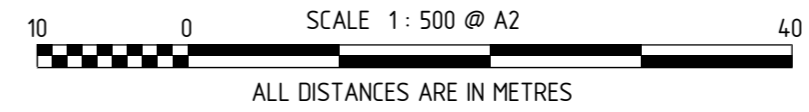

HELD BY LANDGATE IN DIGITAL FORMAT ONLY

FOR HEADING SEE SHEET 1

FOR INTERESTS AND NOTIFICATIONS
SEE SHEET 3

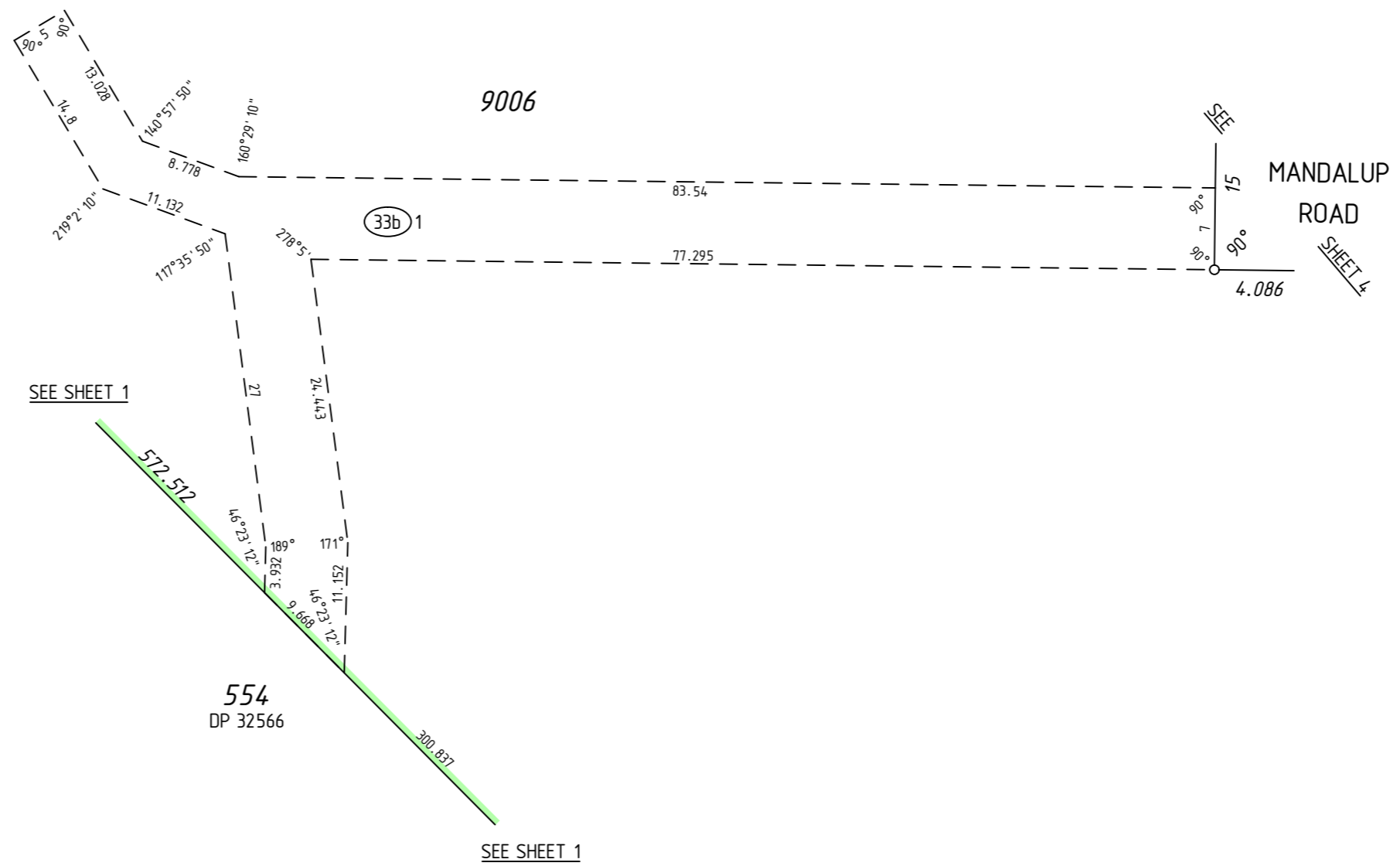

SEE SHEET 1

SEE SHEET 1

SURVEY CARRIED OUT UNDER REG 26A
SPECIAL SURVEY AREA GUIDELINES
SEE SURVEY SHEETS FOR SURVEY INFORMATION

USE ONLY THE SURVEY SHEET/S WHEN DETERMINING
THE TRUE FINAL POSITION AND TYPE OF ALL SURVEY
MARKS PLACED PERTAINING TO THIS PLAN.

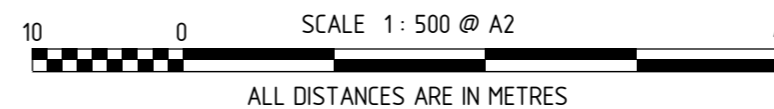

HELD BY LANDGATE IN DIGITAL FORMAT ONLY



MNG Ref : 97602dp-051f - Stage 2B - DP406530.CSD

FINAL

LICENSED SURVEYOR

DATE



GOVERNMENT OF
WESTERN AUSTRALIA



DEPOSITED PLAN

406530

SHEET 05 OF 05 SHEETS
VERSION 1

FOR HEADING SEE SHEET 1

THIS SURVEY SHEET WILL BE
REPLACED BY THE SURVEY DATA



MNG Ref: 97602dp-051f



GOVERNMENT OF
WESTERN AUSTRALIA



DEPOSITED PLAN

406530

SURVEY SHEET