

FOR HEADING SEE SHEET 1

FOR INTERESTS AND NOTIFICATIONS
SEE SHEET 3

ROAD

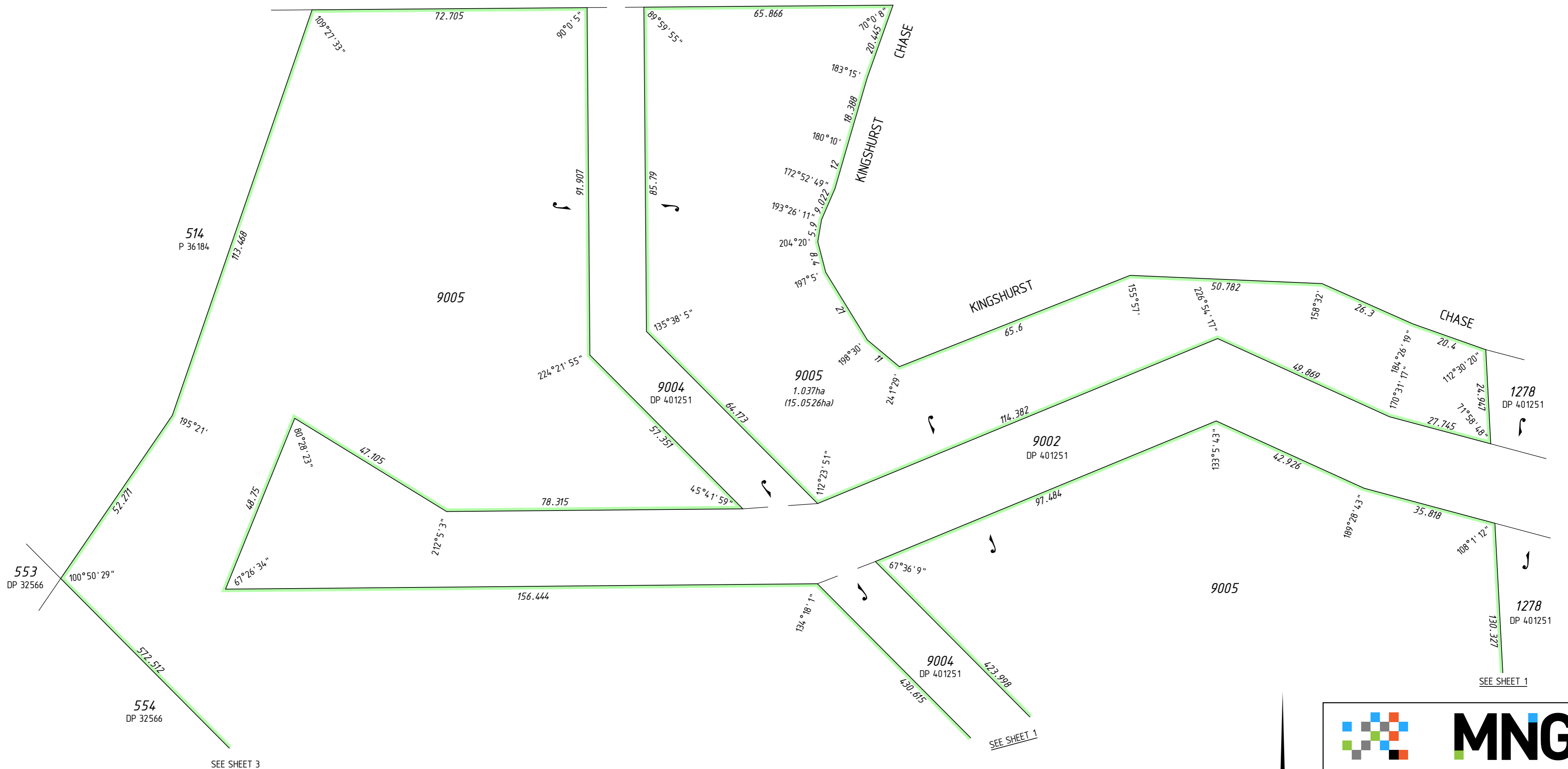

SURVEY CARRIED OUT UNDER REG 26A
SPECIAL SURVEY AREA GUIDELINES

USE ONLY THE SURVEY SHEET/S WHEN DETERMINING
THE TRUE FINAL POSITION AND TYPE OF ALL SURVEY
MARKS PLACED PERTAINING TO THIS PLAN.

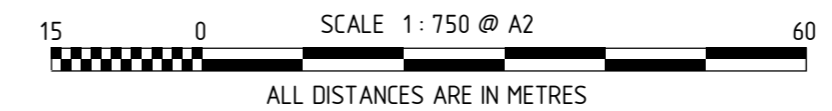

MNG Ref : 97602dp-023i - Stage 2A - DP405419.CSD

FINAL	
LICENSED SURVEYOR	DATE



DEPOSITED PLAN
405419
 SHEET 02 OF 05 SHEETS
 VERSION 2

INTERESTS AND NOTIFICATIONS

SUBJECT	EASEMENT	STATUTORY REFERENCE	ORIGIN	LAND BURDENED	BENEFIT TO	COMMENTS
33b, 33b 1	EASEMENT (Sewerage)	SEC 167 OF THE P. & D. ACT REG 33 (b)	DP 401251	LOT 9005	WATER CORPORATION	
	EASEMENT (Drainage)	SEC 136C OF THE TLA	DP 401251	LOT 1024 ON DP 401251	LOT 9005 (X)	
R1062	EASEMENT (DRAINAGE)	SEC 136C OF THE T.L.A.	THIS PLAN	LOT 1062	LOT 9005 (Y)	
R1060	EASEMENT (DRAINAGE)	SEC 136C OF THE T.L.A.	THIS PLAN	LOT 1060	LOT 1061	
R1058	EASEMENT (DRAINAGE)	SEC 136C OF THE T.L.A.	THIS PLAN	LOT 1058	LOT 1056	
R1055	EASEMENT (DRAINAGE)	SEC 136C OF THE T.L.A.	THIS PLAN	LOT 1055	LOT 1054	
R1053	EASEMENT (DRAINAGE)	SEC 136C OF THE T.L.A.	THIS PLAN	LOT 1053	LOT 1052	
R1035	EASEMENT (DRAINAGE)	SEC 136C OF THE T.L.A.	THIS PLAN	LOT 1035	LOT 1036	
R1033	EASEMENT (DRAINAGE)	SEC 136C OF THE T.L.A.	THIS PLAN	LOT 1033	LOT 1034	
R1031	EASEMENT (DRAINAGE)	SEC 136C OF THE T.L.A.	THIS PLAN	LOT 1031	LOT 1032	
R1029	EASEMENT (DRAINAGE)	SEC 136C OF THE T.L.A.	THIS PLAN	LOT 1029	LOT 1030	
R1027	EASEMENT (DRAINAGE)	SEC 136C OF THE T.L.A.	THIS PLAN	LOT 1027	LOT 1028	
	RESTRICTIVE COVENANT	SEC 136D OF THE T.L.A.	THIS PLAN & DOC N162778	LOTS 1026 - 1036 & 1051 - 1062	LOTS 1026 - 1036 & 1051 - 1062	
A-B	COVENANT	SEC 150 OF THE P. & D. ACT	THIS PLAN	LOT 1058	CITY OF ARMADALE	No road vehicle access to/from Mandalup Road
C-D	COVENANT	SEC 150 OF THE P. & D. ACT	THIS PLAN	LOT 1059	CITY OF ARMADALE	No road vehicle access to/from Coomal Road
E-F	COVENANT	SEC 150 OF THE P. & D. ACT	THIS PLAN	LOT 1026	CITY OF ARMADALE	No road vehicle access to/from Coomal Road
	NOTIFICATION	SEC 165 OF THE P & D ACT	DOC N162779	LOTS 1026 - 1036 & 1051 - 1062		MOSQUITOS
	NOTIFICATION	SEC 70A OF THE T.L.A.	DOC N162780	LOTS 1026 - 1036 & 1051 - 1062		WATER SENSITIVE URBAN DESIGN REQUIREMENTS

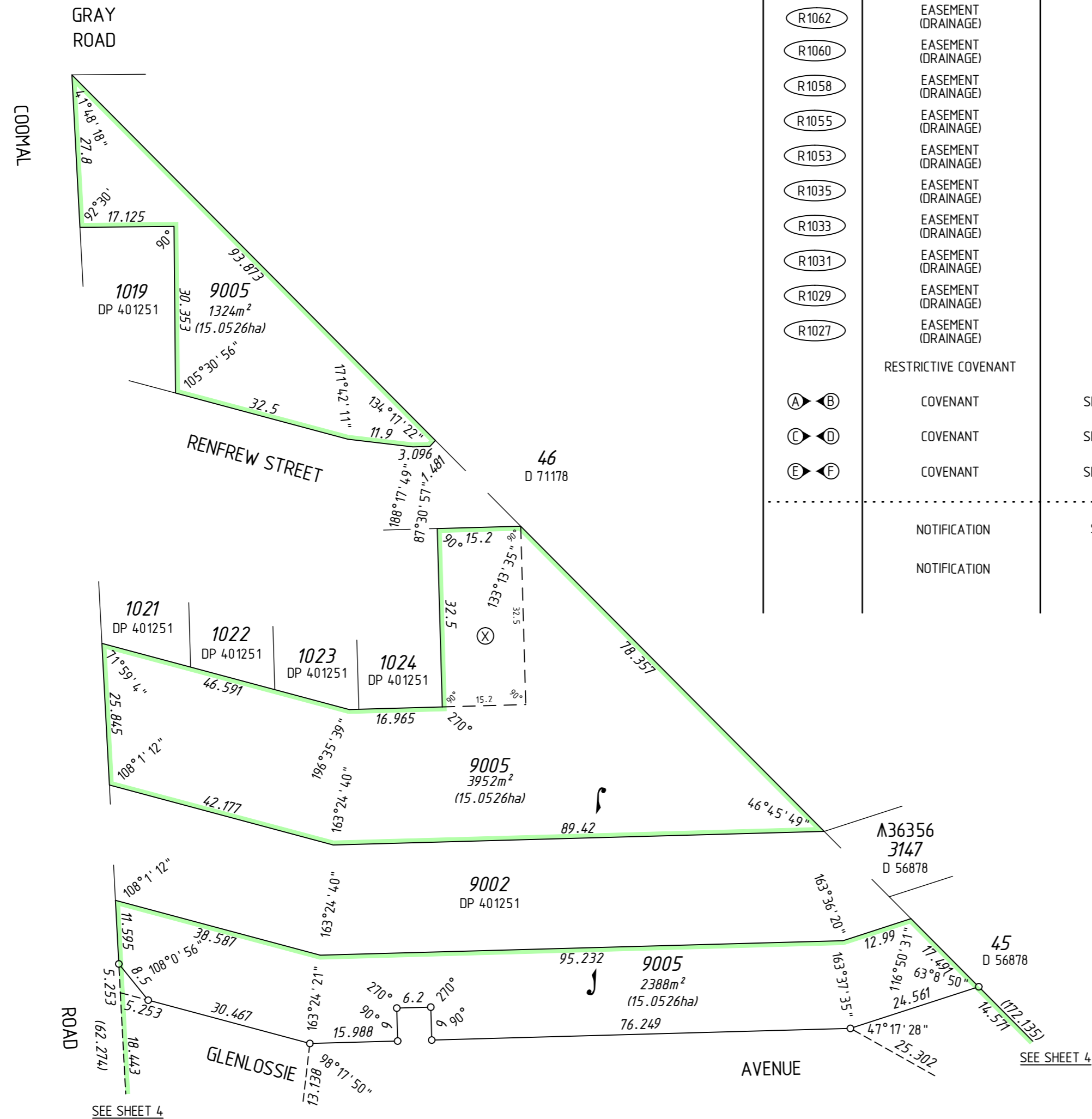

SURVEY CARRIED OUT UNDER REG 26A
SPECIAL SURVEY AREA GUIDELINES

USE ONLY THE SURVEY SHEET/S WHEN DETERMINING
THE TRUE FINAL POSITION AND TYPE OF ALL SURVEY
MARKS PLACED PERTAINING TO THIS PLAN.

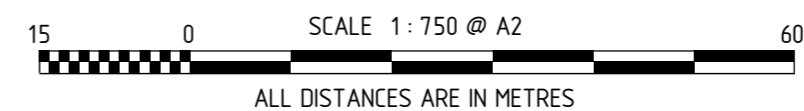

HELD BY LANDGATE IN DIGITAL FORMAT ONLY



MNG Ref : 97602dp-023i - Stage 2A - DP405419.CSD

FINAL

LICENSED SURVEYOR

DATE



DEPOSITED PLAN

405419

SHEET 03 OF 05 SHEETS
VERSION 2

FOR HEADING SEE SHEET 1
FOR INTERESTS AND NOTIFICATIONS SEE SHEET 3

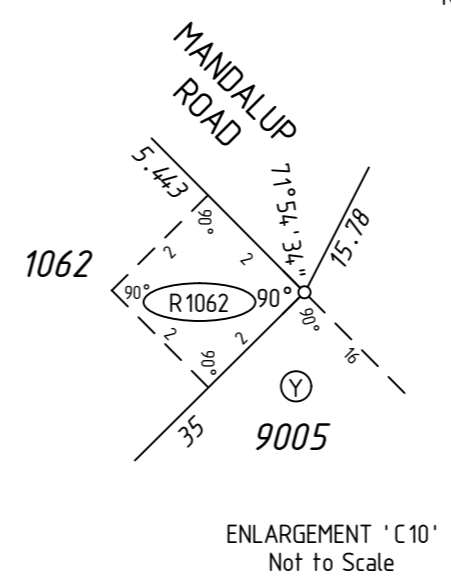
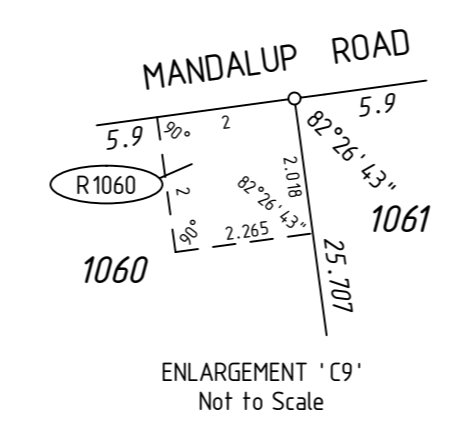
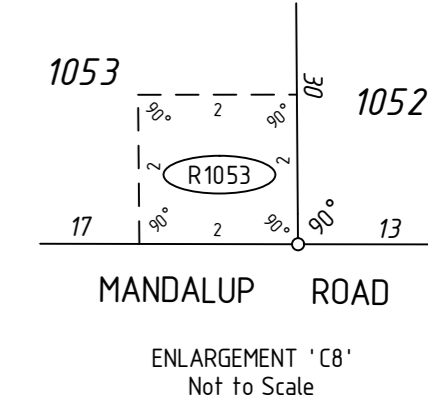
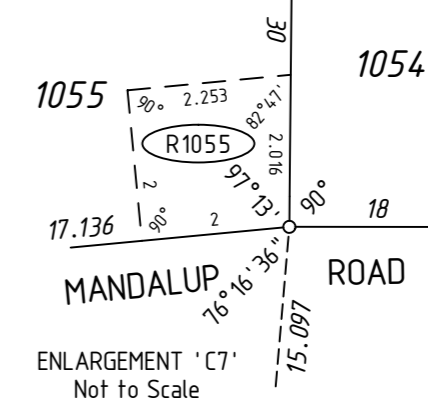
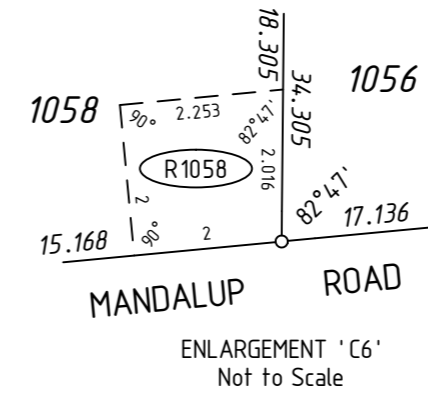
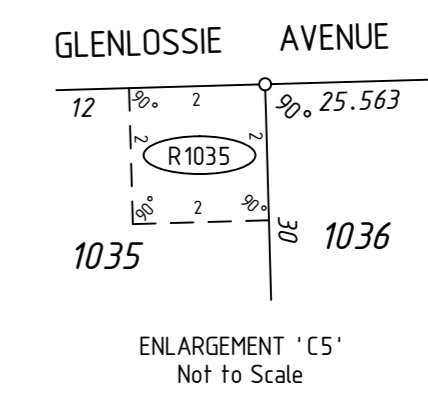
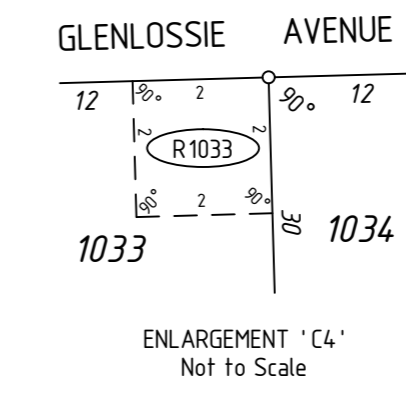
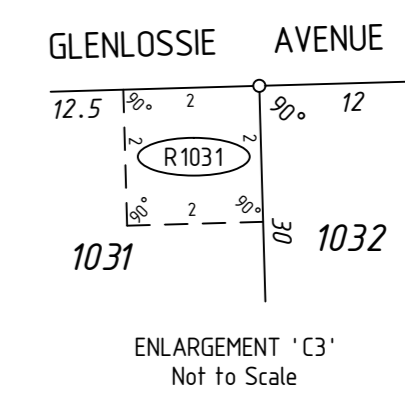
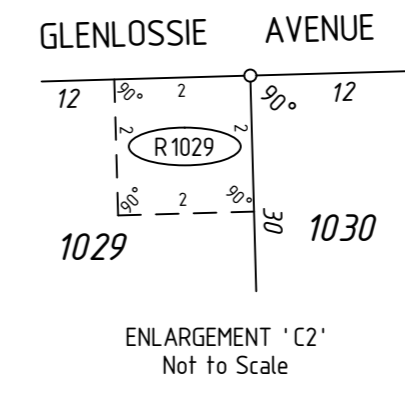
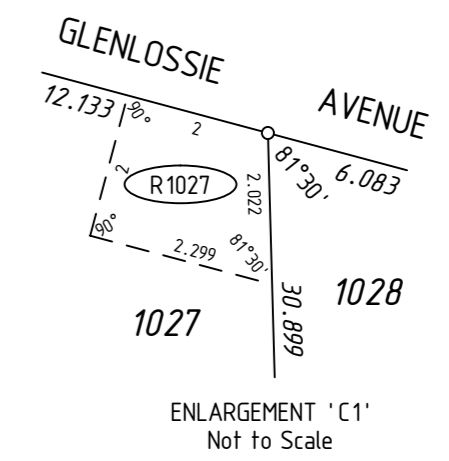
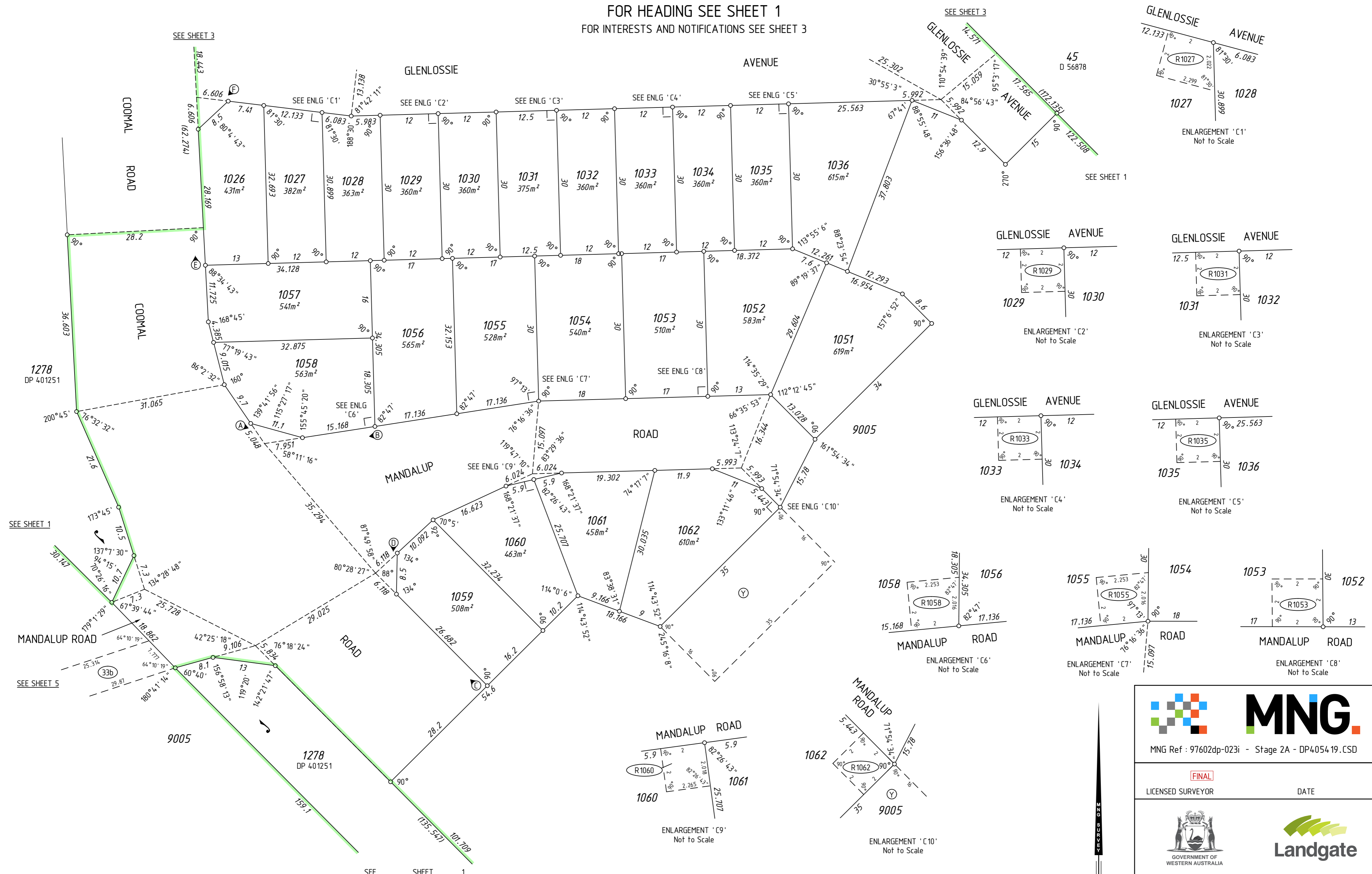

SURVEY CARRIED OUT UNDER REG 26A
SPECIAL SURVEY AREA GUIDELINES

USE ONLY THE SURVEY SHEET/S WHEN DETERMINING
THE TRUE FINAL POSITION AND TYPE OF ALL SURVEY
MARKS PLACED PERTAINING TO THIS PLAN.

HELD BY LANDGATE IN DIGITAL FORMAT ONLY



MNG Ref : 97602dp-023i - Stage 2A - DP405419.CSD

FINAL

LICENSED SURVEYOR DATE



GOVERNMENT OF WESTERN AUSTRALIA

DEPOSITED PLAN
405419
SHEET 04 OF 05 SHEETS
VERSION 2

FOR HEADING SEE SHEET 1

FOR INTERESTS AND NOTIFICATIONS
SEE SHEET 3

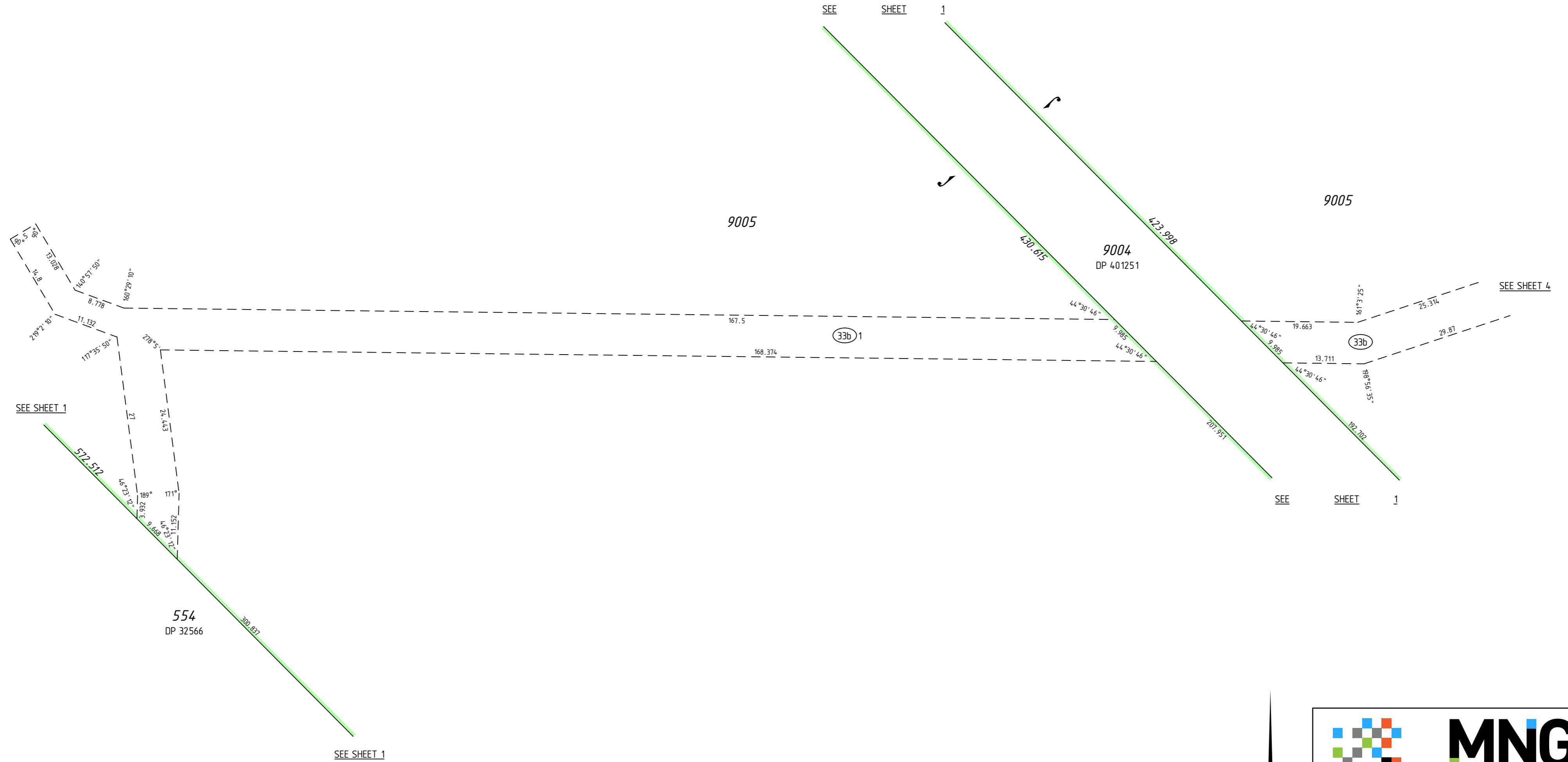

SURVEY CARRIED OUT UNDER REG 26A
SPECIAL SURVEY AREA GUIDELINES

USE ONLY THE SURVEY SHEET/S WHEN DETERMINING
THE TRUE FINAL POSITION AND TYPE OF ALL SURVEY
MARKS PLACED PERTAINING TO THIS PLAN.

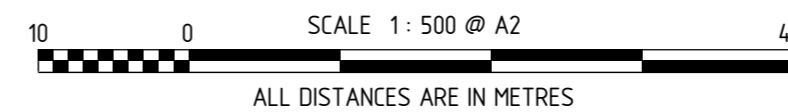

MNG Ref : 97602dp-023i - Stage 2A - DP405419.CSD

FINAL

LICENSED SURVEYOR

DATE



GOVERNMENT OF
WESTERN AUSTRALIA



DEPOSITED PLAN

405419

SHEET 05 OF 05 SHEETS
VERSION 2

FOR HEADING SEE SHEET 1

PRELIMINARY ONLY
UNLODGED VERSION
SUBJECT TO
LANDGATE AUDIT

This version is
- Current as at 9/11/2015
- Subject to change without notice
- Not intended for design use,
a LANDGATE APPROVED copy
should be obtained for such purposes.

THIS SURVEY SHEET WILL BE
REPLACED BY THE SURVEY DATA



MNG Ref: 97602dp-023i



DEPOSITED PLAN

4054 19

SURVEY SHEET